

Introduction

Modelling parallel systems

Linear Time Properties

Regular Properties

Linear Temporal Logic

Computation-Tree Logic

Equivalences and Abstraction

Idea: define **regular LT properties** to be those languages of **infinite words** over the alphabet 2^A that have a representation by a **finite automata**

Idea: define **regular LT properties** to be those languages of **infinite words** over the alphabet 2^{AP} that have a representation by a **finite automata**

- regular safety properties:
NFA-representation for the **bad prefixes**

Idea: define **regular LT properties** to be those languages of **infinite words** over the alphabet 2^{AP} that have a representation by a **finite automata**

- regular safety properties:
NFA-representation for the **bad prefixes**
- other regular LT properties:
representation by **ω -automata**, i.e.,
acceptors for infinite words

Introduction

Modelling parallel systems

Linear Time Properties

Regular Properties

regular safety properties



ω -regular properties

model checking with Büchi automata

Linear Temporal Logic

Computation-Tree Logic

Equivalences and Abstraction

Recall: definition of safety properties

Let E be a LT property over AP , i.e., $E \subseteq (2^{AP})^\omega$.

E is called a **safety property** if for all words

$$\sigma = A_0 A_1 A_2 \dots \in (2^{AP})^\omega \setminus E$$

there exists a finite prefix $A_0 A_1 \dots A_n$ of σ such that *none* of the words $A_0 A_1 \dots A_n B_{n+1} B_{n+2} B_{n+3} \dots$ belongs to E , i.e.,

$$E \cap \{\sigma' \in (2^{AP})^\omega : A_0 \dots A_n \text{ is a prefix of } \sigma'\} = \emptyset$$

Such words $A_0 A_1 \dots A_n$ are called **bad prefixes** for E .

$$\mathit{BadPref} \stackrel{\text{def}}{=} \text{set of bad prefixes for } E \subseteq (2^{AP})^+$$

Let $E \subseteq (2^{AP})^\omega$ be a safety property.

E is called regular iff the language

$BadPref$ = set of all bad prefixes for E

is regular.

Let $E \subseteq (2^{AP})^\omega$ be a safety property.

E is called regular iff the language

$BadPref =$ set of all bad prefixes for $E \subseteq (2^{AP})^+$
is regular.

Let $E \subseteq (2^{AP})^\omega$ be a safety property.

E is called regular iff the language

$BadPref$ = set of all bad prefixes for $E \subseteq (2^{AP})^+$

$BadPref$ = $\mathcal{L}(\mathcal{A})$ for some NFA \mathcal{A}
over the alphabet 2^{AP}

is regular.

NFA $\mathcal{A} = (Q, \Sigma, \delta, Q_0, F)$

- Q finite set of states
- Σ alphabet
- $\delta : Q \times \Sigma \rightarrow 2^Q$ transition relation
- $Q_0 \subseteq Q$ set of initial states
- $F \subseteq Q$ set of **final states**, also called **accept states**

NFA $\mathcal{A} = (Q, \Sigma, \delta, Q_0, F)$

- Q finite set of states
- Σ alphabet
- $\delta : Q \times \Sigma \rightarrow 2^Q$ transition relation
- $Q_0 \subseteq Q$ set of initial states
- $F \subseteq Q$ set of **final states**, also called **accept states**

run for a word $A_0 A_1 \dots A_{n-1} \in \Sigma^*$:

state sequence $\pi = q_0 q_1 \dots q_n$ where $q_0 \in Q_0$
and $q_{i+1} \in \delta(q_i, A_i)$ for $0 \leq i < n$

NFA $\mathcal{A} = (Q, \Sigma, \delta, Q_0, F)$

- Q finite set of states
- Σ alphabet
- $\delta : Q \times \Sigma \rightarrow 2^Q$ transition relation
- $Q_0 \subseteq Q$ set of initial states
- $F \subseteq Q$ set of final states, also called accept states

run for a word $A_0 A_1 \dots A_{n-1} \in \Sigma^*$:

state sequence $\pi = q_0 q_1 \dots q_n$ where $q_0 \in Q_0$
and $q_{i+1} \in \delta(q_i, A_i)$ for $0 \leq i < n$

run π is called accepting if $q_n \in F$

NFA $\mathcal{A} = (Q, \Sigma, \delta, Q_0, F)$

- Q finite set of states
- Σ alphabet
- $\delta : Q \times \Sigma \rightarrow 2^Q$ transition relation
- $Q_0 \subseteq Q$ set of initial states
- $F \subseteq Q$ set of **final states**, also called **accept states**

accepted language $\mathcal{L}(\mathcal{A}) \subseteq \Sigma^*$ is given by:

$\mathcal{L}(\mathcal{A}) =$ set of finite words over Σ that have
an **accepting run** in \mathcal{A}

NFA $\mathcal{A} = (Q, \Sigma, \delta, Q_0, F)$

- Q finite set of states
- Σ alphabet \leftarrow here: $\Sigma = 2^{AP}$
- $\delta : Q \times \Sigma \rightarrow 2^Q$ transition relation
- $Q_0 \subseteq Q$ set of initial states
- $F \subseteq Q$ set of **final states**, also called **accept states**

accepted language $\mathcal{L}(\mathcal{A}) \subseteq \Sigma^*$ is given by:

$\mathcal{L}(\mathcal{A}) =$ set of finite words over Σ that have an **accepting run** in \mathcal{A}

Notations in pictures for NFA

is2.5-15A

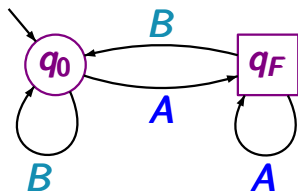

↘ initial state

○ nonfinal state

□ final state

Notations in pictures for NFA

is2.5-15A

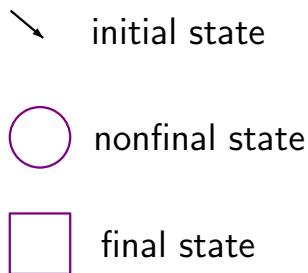
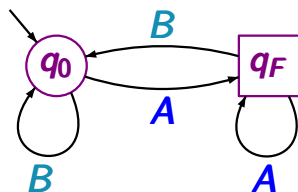

NFA \mathcal{A} with state space $\{q_0, q_F\}$

q_0 initial state

q_F final state

alphabet $\Sigma = \{A, B\}$

Notations in pictures for NFA

is2.5-15A

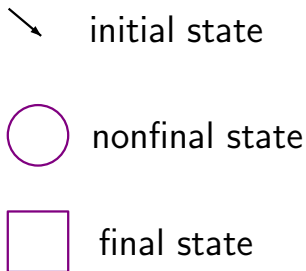
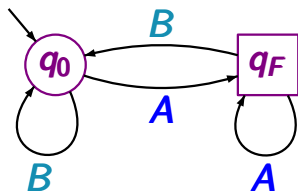

accepted language $\mathcal{L}(\mathcal{A})$:

set of all finite words over $\{A, B\}$
ending with letter A

for transitions in **NFA** over the alphabet $\Sigma = 2^{AP}$

NFA $\mathcal{A} = (Q, \Sigma, \delta, Q_0, F)$ over the alphabet $\Sigma = 2^{AP}$
symbolic notation for the labels of transitions:

If ϕ is a propositional formula over AP then

$q \xrightarrow{\phi} p$ stands for the set of transitions $q \xrightarrow{A} p$

where $A \subseteq AP$ such that $A \models \phi$

NFA $\mathcal{A} = (Q, \Sigma, \delta, Q_0, F)$ over the alphabet $\Sigma = 2^{AP}$
symbolic notation for the labels of transitions:

If Φ is a propositional formula over AP then

$q \xrightarrow{\Phi} p$ stands for the set of transitions $q \xrightarrow{A} p$

where $A \subseteq AP$ such that $A \models \Phi$

Example: if $AP = \{a, b, c\}$ then

$q \xrightarrow{a \wedge \neg b} p \hat{=} \{ q \xrightarrow{A} p : A = \{a, c\} \text{ or } A = \{a\} \}$

NFA $\mathcal{A} = (Q, \Sigma, \delta, Q_0, F)$ over the alphabet $\Sigma = 2^{AP}$
symbolic notation for the labels of transitions:

If Φ is a propositional formula over AP then

$q \xrightarrow{\Phi} p$ stands for the set of transitions $q \xrightarrow{A} p$

where $A \subseteq AP$ such that $A \models \Phi$

Example: if $AP = \{a, b, c\}$ then

$q \xrightarrow{a \wedge \neg b} p \hat{=} \{ q \xrightarrow{A} p : A = \{a, c\} \text{ or } A = \{a\} \}$

$q \xrightarrow{\text{true}} p \hat{=} \{ q \xrightarrow{A} p : A \subseteq AP \}$

A safety property $E \subseteq (2^{AP})^\omega$ is called regular iff

$BadPref$ = set of all bad prefixes for $E \subseteq (2^{AP})^+$

$BadPref = \mathcal{L}(\mathcal{A})$ for some NFA \mathcal{A}
over the alphabet 2^{AP}

is regular.

A safety property $E \subseteq (2^{AP})^\omega$ is called regular iff

$BadPref$ = set of all bad prefixes for $E \subseteq (2^{AP})^+$

$BadPref = \mathcal{L}(\mathcal{A})$ for some NFA \mathcal{A}
over the alphabet 2^{AP}

is regular.

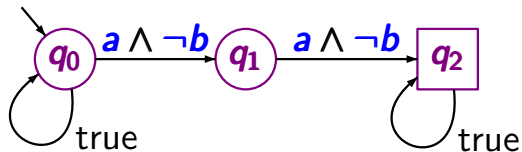

$AP = \{a, b\}$

A safety property $E \subseteq (2^{AP})^\omega$ is called regular iff

$BadPref$ = set of all bad prefixes for $E \subseteq (2^{AP})^+$

$BadPref = \mathcal{L}(\mathcal{A})$ for some NFA \mathcal{A}
over the alphabet 2^{AP}

is regular.

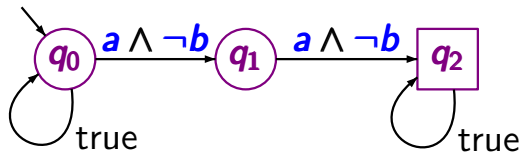

$AP = \{a, b\}$

symbolic notation:

$a \wedge \neg b \hat{=} \{a\}$

A safety property $E \subseteq (2^{AP})^\omega$ is called regular iff

$BadPref$ = set of all bad prefixes for $E \subseteq (2^{AP})^+$

$BadPref = \mathcal{L}(\mathcal{A})$ for some NFA \mathcal{A}
over the alphabet 2^{AP}

is regular.

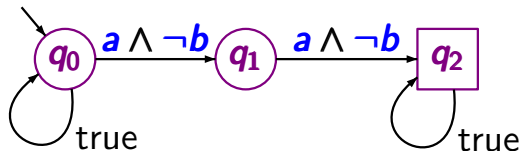

$AP = \{a, b\}$

symbolic notation:

$a \wedge \neg b \hat{=} \{a\}$

safety property E : “ $a \wedge \neg b$ never holds twice in a row”

“Every red phase is preceded by a yellow phase”

“Every red phase is preceded by a yellow phase”

set of all infinite words $A_0 A_1 A_2 \dots$ s.t. for all $i \geq 0$:

$$\text{red} \in A_i \implies i \geq 1 \text{ and } \text{yellow} \in A_{i-1}$$

Example: regular safety property

IS2.5-16

“Every red phase is preceded by a yellow phase”

set of all infinite words $A_0 A_1 A_2 \dots$ s.t. for all $i \geq 0$:

$$\text{red} \in A_i \implies i \geq 1 \text{ and } \text{yellow} \in A_{i-1}$$

DFA for all (possibly non-minimal) bad prefixes

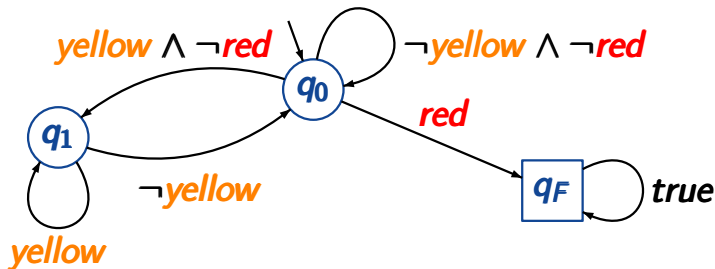

Example: regular safety property

IS2.5-16

“Every red phase is preceded by a yellow phase”

set of all infinite words $A_0 A_1 A_2 \dots$ s.t. for all $i \geq 0$:

$$\text{red} \in A_i \implies i \geq 1 \text{ and } \text{yellow} \in A_{i-1}$$

DFA for minimal bad prefixes

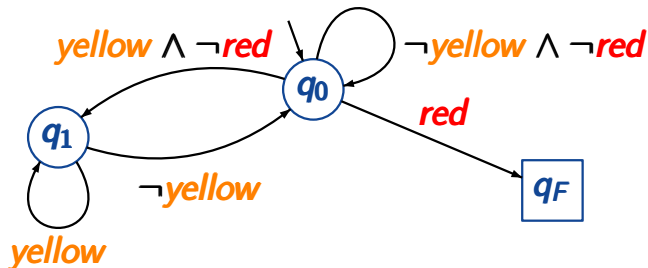

Let $E \subseteq (2^{AP})^\omega$ be a safety property.

BadPref = set of all bad prefixes for E

MinBadPref = set of minimal bad prefixes for E

*Claim: *BadPref* is regular \iff *MinBadPref* is regular*

Let $E \subseteq (2^{AP})^\omega$ be a safety property.

BadPref = set of all bad prefixes for E

MinBadPref = set of minimal bad prefixes for E

Claim: $BadPref$ is regular \iff $MinBadPref$ is regular

“ \Leftarrow ”: Let \mathcal{A} be an NFA for *MinBadPref*.

Let $E \subseteq (2^{AP})^\omega$ be a safety property.

BadPref = set of all bad prefixes for E

MinBadPref = set of minimal bad prefixes for E

Claim: $BadPref$ is regular \iff $MinBadPref$ is regular

“ \Leftarrow ”: Let \mathcal{A} be an NFA for *MinBadPref*.

An NFA \mathcal{A}' for *BadPref* is obtained from \mathcal{A} by adding self-loops $p \xrightarrow{true} p$ to all final states p .

Let $E \subseteq (2^{AP})^\omega$ be a safety property.

BadPref = set of all bad prefixes for E

MinBadPref = set of minimal bad prefixes for E

Claim: BadPref is regular \iff *MinBadPref* is regular

“ \Leftarrow ”: Let \mathcal{A} be an NFA for *MinBadPref*.

An NFA \mathcal{A}' for *BadPref* is obtained from \mathcal{A} by adding self-loops $p \xrightarrow{\text{true}} p$ to all final states p .

“ \Rightarrow ”: Let \mathcal{A} be a DFA for *BadPref*.

Let $E \subseteq (2^{AP})^\omega$ be a safety property.

BadPref = set of all bad prefixes for E

MinBadPref = set of minimal bad prefixes for E

Claim: BadPref is regular \iff *MinBadPref* is regular

“ \Leftarrow ”: Let \mathcal{A} be an NFA for *MinBadPref*.

An NFA \mathcal{A}' for *BadPref* is obtained from \mathcal{A} by adding self-loops $p \xrightarrow{\text{true}} p$ to all final states p .

“ \Rightarrow ”: Let \mathcal{A} be a DFA for *BadPref*.

A DFA \mathcal{A}' for *MinBadPref* is obtained from \mathcal{A} by removing all outgoing transitions of final states.

Every **invariant** is regular.

Every **invariant** is regular.

correct.

Every **invariant** is regular.

correct.

Let **E** be an invariant with invariant condition Φ

Every invariant is regular.

correct.

Let E be an invariant with invariant condition Φ

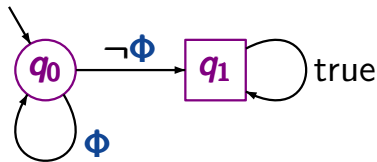

is a DFA for the language of all bad prefixes

Every invariant is regular.

correct.

Let E be an invariant with invariant condition Φ

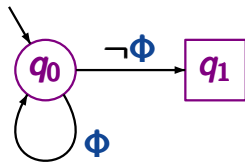

is a DFA for the language of all minimal bad prefixes

“The two processes are never simultaneously
in their critical sections”

Example: DFA for *MUTEX*

IS2.5-19

“The two processes are **never simultaneously**
in their **critical sections**”

DFA for minimal bad prefixes over the alphabet 2^{AP} where $AP = \{\text{crit}_1, \text{crit}_2\}$

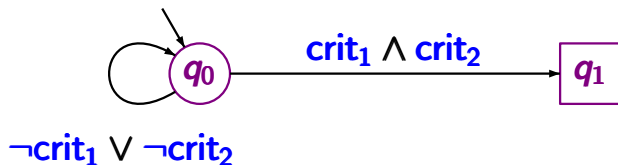

Every **safety property** is regular.

Every **safety property** is regular.

wrong.

Every **safety property** is regular.

wrong. e.g., $AP = \{\text{pay}, \text{drink}\}$

E = set of all infinite words $A_0 A_1 A_2 \dots \in (2^{AP})^\omega$
such that for all $j \in \mathbb{N}$:

$$|\{i \leq j : \text{pay} \in A_i\}| \geq |\{i \leq j : \text{drink} \in A_i\}|$$

Every **safety property** is regular.

wrong. e.g., $AP = \{\text{pay}, \text{drink}\}$

E = set of all infinite words $A_0 A_1 A_2 \dots \in (2^{AP})^\omega$
such that for all $j \in \mathbb{N}$:

$$|\{i \leq j : \text{pay} \in A_i\}| \geq |\{i \leq j : \text{drink} \in A_i\}|$$

- E is a safety property, but
- the language of (minimal) bad prefixes is *not* regular

given: finite TS \mathcal{T}
 regular safety property E
 (represented by an **NFA** for its bad prefixes)

question: does $\mathcal{T} \models E$ hold ?

given: finite TS \mathcal{T}
 regular safety property E
 (represented by an **NFA** for its bad prefixes)

question: does $\mathcal{T} \models E$ hold ?

method: relies on an analogy between the tasks:

- checking **language inclusion** for **NFA**
- model checking regular safety properties

language inclusion
for NFA

$$\mathcal{L}(\mathcal{A}_1) \subseteq \mathcal{L}(\mathcal{A}_2) ?$$

verification of regular
safety properties

$$\text{Traces}(\mathcal{T}) \subseteq E ?$$

language inclusion
for NFA

$$\mathcal{L}(\mathcal{A}_1) \subseteq \mathcal{L}(\mathcal{A}_2) ?$$

check whether

$$\mathcal{L}(\mathcal{A}_1) \cap (\Sigma^* \setminus \mathcal{L}(\mathcal{A}_2))$$

is empty

verification of regular
safety properties

$$\text{Traces}(\mathcal{T}) \subseteq E ?$$

language inclusion
for NFA

$$\mathcal{L}(\mathcal{A}_1) \subseteq \mathcal{L}(\mathcal{A}_2) ?$$

check whether

$$\mathcal{L}(\mathcal{A}_1) \cap (\Sigma^* \setminus \mathcal{L}(\mathcal{A}_2))$$

is empty

1. complement \mathcal{A}_2 , i.e.,
construct NFA $\overline{\mathcal{A}_2}$ with
 $\mathcal{L}(\overline{\mathcal{A}_2}) = \Sigma^* \setminus \mathcal{L}(\mathcal{A}_2)$

verification of regular
safety properties

$$\text{Traces}(\mathcal{T}) \subseteq E ?$$

language inclusion
for NFA

$$\mathcal{L}(\mathcal{A}_1) \subseteq \mathcal{L}(\mathcal{A}_2) ?$$

check whether

$$\mathcal{L}(\mathcal{A}_1) \cap (\Sigma^* \setminus \mathcal{L}(\mathcal{A}_2))$$

is empty

1. complement \mathcal{A}_2 , i.e.,
construct NFA $\overline{\mathcal{A}_2}$ with
 $\mathcal{L}(\overline{\mathcal{A}_2}) = \Sigma^* \setminus \mathcal{L}(\mathcal{A}_2)$
2. construct NFA \mathcal{A} with
 $\mathcal{L}(\mathcal{A}) = \mathcal{L}(\mathcal{A}_1) \cap \mathcal{L}(\overline{\mathcal{A}_2})$

verification of regular
safety properties

$$\text{Traces}(\mathcal{T}) \subseteq E ?$$

language inclusion
for NFA

verification of regular
safety properties

$$\mathcal{L}(\mathcal{A}_1) \subseteq \mathcal{L}(\mathcal{A}_2) ?$$

$$\text{Traces}(\mathcal{T}) \subseteq E ?$$

check whether

$$\mathcal{L}(\mathcal{A}_1) \cap (\Sigma^* \setminus \mathcal{L}(\mathcal{A}_2))$$

is empty

1. complement \mathcal{A}_2 , i.e.,
construct NFA $\overline{\mathcal{A}_2}$ with
 $\mathcal{L}(\overline{\mathcal{A}_2}) = \Sigma^* \setminus \mathcal{L}(\mathcal{A}_2)$
2. construct NFA \mathcal{A} with
 $\mathcal{L}(\mathcal{A}) = \mathcal{L}(\mathcal{A}_1) \cap \mathcal{L}(\overline{\mathcal{A}_2})$
3. check if $\mathcal{L}(\mathcal{A}) = \emptyset$

language inclusion
for NFA

$$\mathcal{L}(\mathcal{A}_1) \subseteq \mathcal{L}(\mathcal{A}_2) ?$$

check whether

$$\mathcal{L}(\mathcal{A}_1) \cap (\Sigma^* \setminus \mathcal{L}(\mathcal{A}_2))$$

is empty

1. complement \mathcal{A}_2 , i.e.,
construct NFA $\overline{\mathcal{A}_2}$ with
 $\mathcal{L}(\overline{\mathcal{A}_2}) = \Sigma^* \setminus \mathcal{L}(\mathcal{A}_2)$
2. construct NFA \mathcal{A} with
 $\mathcal{L}(\mathcal{A}) = \mathcal{L}(\mathcal{A}_1) \cap \mathcal{L}(\overline{\mathcal{A}_2})$
3. check if $\mathcal{L}(\mathcal{A}) = \emptyset$

verification of regular
safety properties

$$\text{Traces}(\mathcal{T}) \subseteq E ?$$

check whether

$$\text{Traces}_{fin}(\mathcal{T}) \cap \text{BadPref}$$

is empty

language inclusion
for NFA

$$\mathcal{L}(\mathcal{A}_1) \subseteq \mathcal{L}(\mathcal{A}_2) ?$$

check whether

$$\mathcal{L}(\mathcal{A}_1) \cap (\Sigma^* \setminus \mathcal{L}(\mathcal{A}_2))$$

is empty

1. complement \mathcal{A}_2 , i.e.,
construct NFA $\overline{\mathcal{A}_2}$ with
 $\mathcal{L}(\overline{\mathcal{A}_2}) = \Sigma^* \setminus \mathcal{L}(\mathcal{A}_2)$
2. construct NFA \mathcal{A} with
 $\mathcal{L}(\mathcal{A}) = \mathcal{L}(\mathcal{A}_1) \cap \mathcal{L}(\overline{\mathcal{A}_2})$
3. check if $\mathcal{L}(\mathcal{A}) = \emptyset$

verification of regular
safety properties

$$\text{Traces}(\mathcal{T}) \subseteq E ?$$

check whether

$$\text{Traces}_{fin}(\mathcal{T}) \cap \text{BadPref}$$

is empty

1. construct NFA \mathcal{A}
for the bad prefixes
 $\mathcal{L}(\overline{\mathcal{A}}) = \text{BadPref}$

language inclusion
for NFA

$$\mathcal{L}(\mathcal{A}_1) \subseteq \mathcal{L}(\mathcal{A}_2) ?$$

check whether

$$\mathcal{L}(\mathcal{A}_1) \cap (\Sigma^* \setminus \mathcal{L}(\mathcal{A}_2))$$

is empty

1. complement \mathcal{A}_2 , i.e.,
construct NFA $\overline{\mathcal{A}_2}$ with
 $\mathcal{L}(\overline{\mathcal{A}_2}) = \Sigma^* \setminus \mathcal{L}(\mathcal{A}_2)$
2. construct NFA \mathcal{A} with
 $\mathcal{L}(\mathcal{A}) = \mathcal{L}(\mathcal{A}_1) \cap \mathcal{L}(\overline{\mathcal{A}_2})$
3. check if $\mathcal{L}(\mathcal{A}) = \emptyset$

verification of regular
safety properties

$$\text{Traces}(\mathcal{T}) \subseteq E ?$$

check whether

$$\text{Traces}_{fin}(\mathcal{T}) \cap \text{BadPref}$$

is empty

1. construct NFA \mathcal{A}
for the bad prefixes
 $\mathcal{L}(\overline{\mathcal{A}}) = \text{BadPref}$
2. construct TS \mathcal{T}' with
 $\text{Traces}_{fin}(\mathcal{T}') = \dots$

language inclusion
for NFA

$$\mathcal{L}(\mathcal{A}_1) \subseteq \mathcal{L}(\mathcal{A}_2) ?$$

check whether

$$\mathcal{L}(\mathcal{A}_1) \cap (\Sigma^* \setminus \mathcal{L}(\mathcal{A}_2))$$

is empty

1. complement \mathcal{A}_2 , i.e.,
construct NFA $\overline{\mathcal{A}_2}$ with
 $\mathcal{L}(\overline{\mathcal{A}_2}) = \Sigma^* \setminus \mathcal{L}(\mathcal{A}_2)$
2. construct NFA \mathcal{A} with
 $\mathcal{L}(\mathcal{A}) = \mathcal{L}(\mathcal{A}_1) \cap \mathcal{L}(\overline{\mathcal{A}_2})$
3. check if $\mathcal{L}(\mathcal{A}) = \emptyset$

verification of regular
safety properties

$$\text{Traces}(\mathcal{T}) \subseteq E ?$$

check whether

$$\text{Traces}_{fin}(\mathcal{T}) \cap \text{BadPref}$$

is empty

1. construct NFA \mathcal{A}
for the bad prefixes
 $\mathcal{L}(\overline{\mathcal{A}}) = \text{BadPref}$
2. construct TS \mathcal{T}' with
 $\text{Traces}_{fin}(\mathcal{T}') = \dots$
3. invariant checking
for \mathcal{T}'

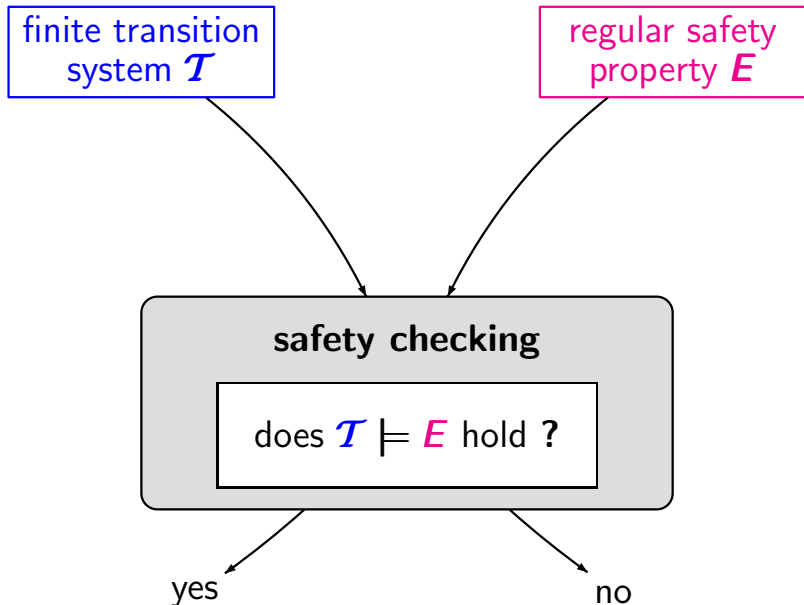

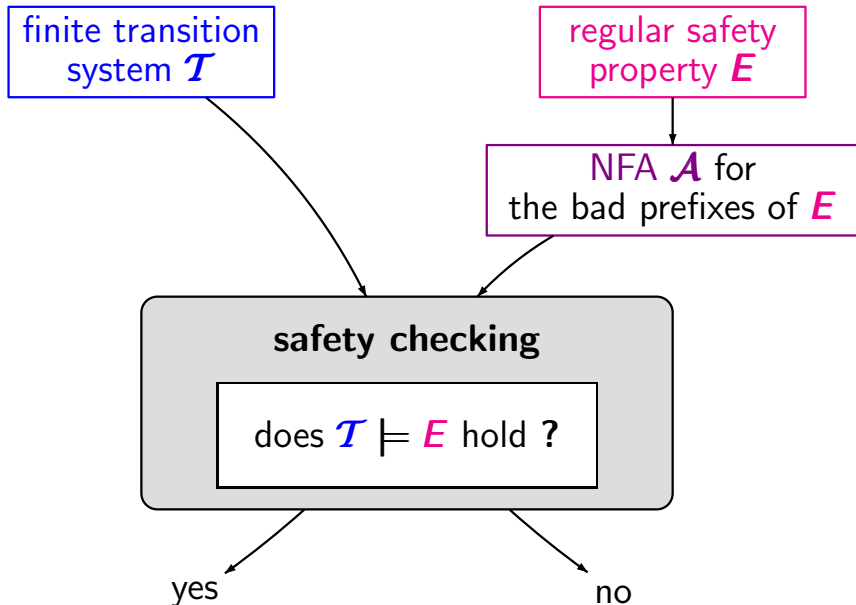

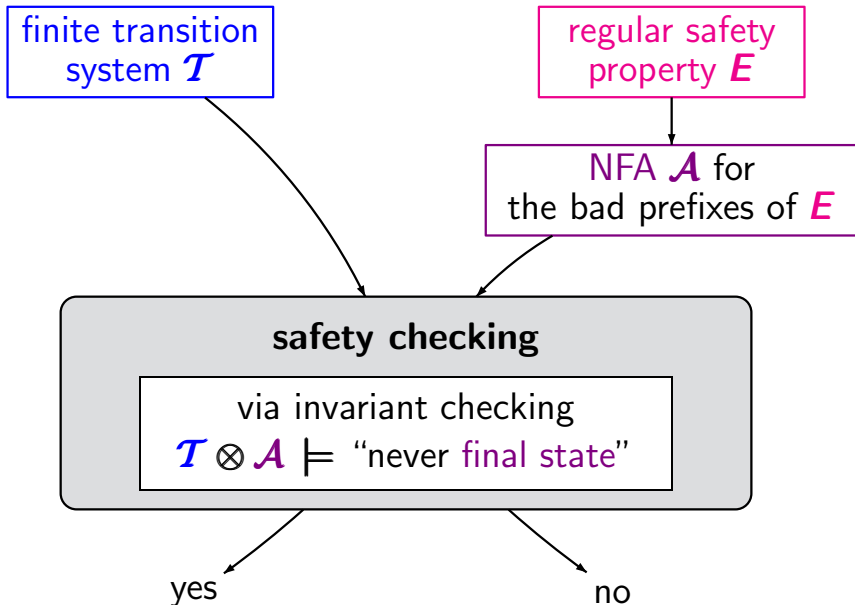

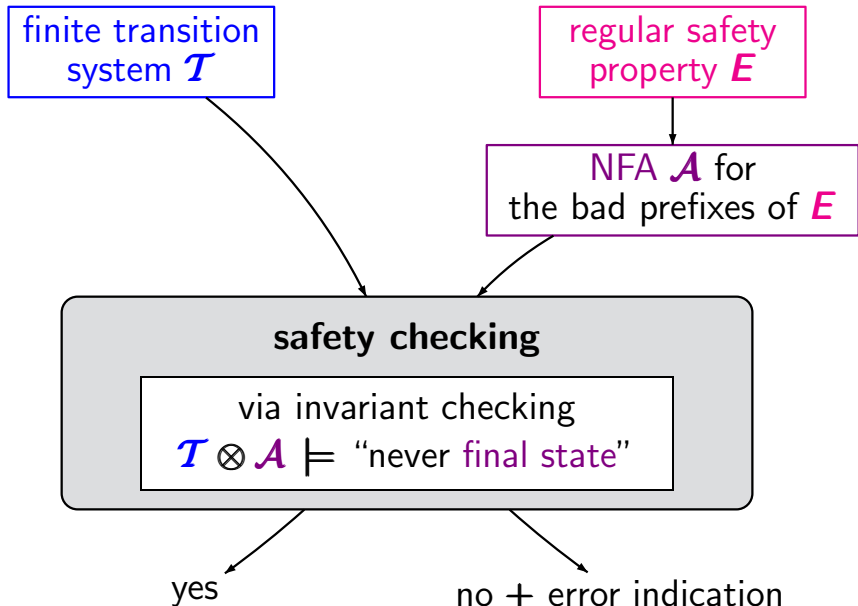

Product of a TS and an NFA

IS2.5-22

finite transition system

$$\mathcal{T} = (S, Act, \rightarrow, S_0, AP, L)$$

NFA for bad prefixes

$$\mathcal{A} = (Q, 2^{AP}, \delta, Q_0, F)$$

s_0



s_1



s_2



\vdots



s_n

path
fragment $\hat{\pi}$

Product of a TS and an NFA

IS2.5-22

finite transition system

$$\mathcal{T} = (S, Act, \rightarrow, S_0, AP, L)$$

NFA for bad prefixes

$$\mathcal{A} = (Q, 2^{AP}, \delta, Q_0, F)$$

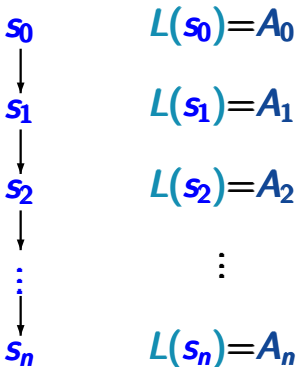

path
fragment $\hat{\pi}$

trace

Product of a TS and an NFA

IS2.5-22

finite transition system

$$\mathcal{T} = (S, Act, \rightarrow, S_0, AP, L)$$

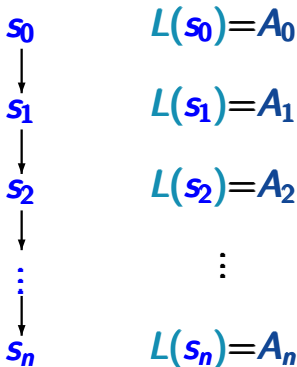

path
fragment $\hat{\pi}$

trace

NFA for bad prefixes

$$\mathcal{A} = (Q, 2^{AP}, \delta, Q_0, F)$$

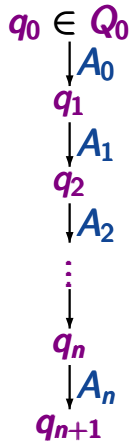

run for $trace(\hat{\pi})$

Product of a TS and an NFA

IS2.5-22

finite transition system

$$\mathcal{T} = (S, Act, \rightarrow, S_0, AP, L)$$

NFA for bad prefixes

$$\mathcal{A} = (Q, 2^{AP}, \delta, Q_0, F)$$

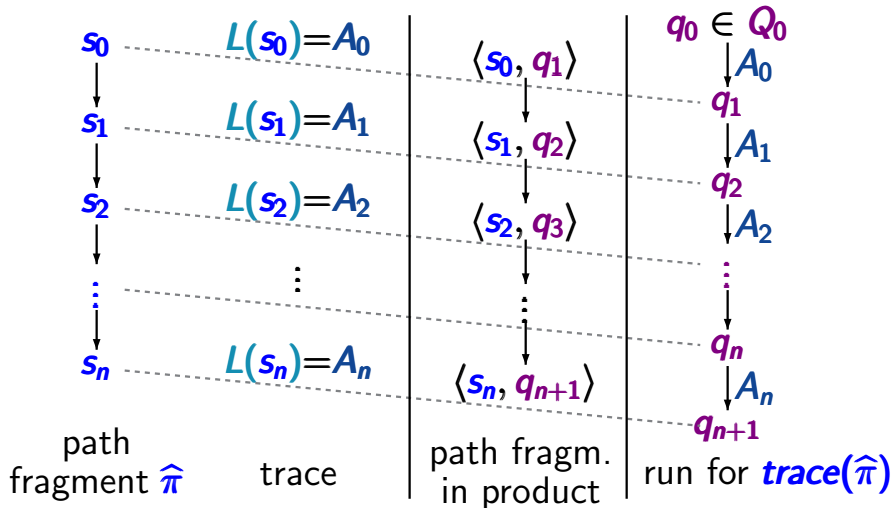

$\mathcal{T} = (S, Act, \rightarrow, S_0, AP, L)$ transition system

$\mathcal{A} = (Q, 2^{AP}, \delta, Q_0, F)$ NFA

$\mathcal{T} = (S, Act, \rightarrow, S_0, AP, L)$ transition system

$\mathcal{A} = (Q, 2^{AP}, \delta, Q_0, F)$ NFA

product-TS $\mathcal{T} \otimes \mathcal{A} \stackrel{\text{def}}{=} (S \times Q, Act, \longrightarrow', S'_0, AP', L')$

$\mathcal{T} = (S, Act, \rightarrow, S_0, AP, L)$ transition system

$\mathcal{A} = (Q, 2^{AP}, \delta, Q_0, F)$ NFA

product-TS $\mathcal{T} \otimes \mathcal{A} \stackrel{\text{def}}{=} (S \times Q, Act, \longrightarrow', S'_0, AP', L')$

$$\frac{s \xrightarrow{\alpha} s' \quad \wedge \quad q' \in \delta(q, L(s'))}{\langle s, q \rangle \xrightarrow{\alpha}' \langle s', q' \rangle}$$

$\mathcal{T} = (S, Act, \rightarrow, S_0, AP, L)$ transition system

$\mathcal{A} = (Q, 2^{AP}, \delta, Q_0, F)$ NFA

product-TS $\mathcal{T} \otimes \mathcal{A} \stackrel{\text{def}}{=} (S \times Q, Act, \longrightarrow', S'_0, AP', L')$

$$\frac{s \xrightarrow{\alpha} s' \quad \wedge \quad q' \in \delta(q, L(s'))}{\langle s, q \rangle \xrightarrow{\alpha}' \langle s', q' \rangle}$$

initial states: $S'_0 = \{ \langle s_0, q \rangle : s_0 \in S_0, q \in \delta(Q_0, L(s_0)) \}$

Product transition system

IS2.5-25

$\mathcal{T} = (S, \text{Act}, \rightarrow, S_0, AP, L)$ transition system

$\mathcal{A} = (Q, 2^{AP}, \delta, Q_0, F)$ NFA

product-TS $\mathcal{T} \otimes \mathcal{A} \stackrel{\text{def}}{=} (S \times Q, \text{Act}, \longrightarrow', S'_0, AP', L')$

$$\frac{s \xrightarrow{\alpha} s' \quad \wedge \quad q' \in \delta(q, L(s'))}{\langle s, q \rangle \xrightarrow{\alpha}' \langle s', q' \rangle}$$

initial states: $S'_0 = \{ \langle s_0, q \rangle : s_0 \in S_0, q \in \delta(Q_0, L(s_0)) \}$

for $P \subseteq Q$ and $A \subseteq AP$: $\delta(P, A) = \bigcup_{p \in P} \delta(p, A)$

$\mathcal{T} = (S, Act, \rightarrow, S_0, AP, L)$ transition system

$\mathcal{A} = (Q, 2^{AP}, \delta, Q_0, F)$ NFA

product-TS $\mathcal{T} \otimes \mathcal{A} \stackrel{\text{def}}{=} (S \times Q, Act, \longrightarrow', S'_0, AP', L')$

$$\frac{s \xrightarrow{\alpha} s' \quad \wedge \quad q' \in \delta(q, L(s'))}{\langle s, q \rangle \xrightarrow{\alpha}' \langle s', q' \rangle}$$

initial states: $S'_0 = \{ \langle s_0, q \rangle : s_0 \in S_0, q \in \delta(Q_0, L(s_0)) \}$

set of atomic propositions: $AP' = Q$

$\mathcal{T} = (S, Act, \rightarrow, S_0, AP, L)$ transition system

$\mathcal{A} = (Q, 2^{AP}, \delta, Q_0, F)$ NFA

product-TS $\mathcal{T} \otimes \mathcal{A} \stackrel{\text{def}}{=} (S \times Q, Act, \longrightarrow', S'_0, AP', L')$

$$\frac{s \xrightarrow{\alpha} s' \quad \wedge \quad q' \in \delta(q, L(s'))}{\langle s, q \rangle \xrightarrow{\alpha}' \langle s', q' \rangle}$$

initial states: $S'_0 = \{ \langle s_0, q \rangle : s_0 \in S_0, q \in \delta(Q_0, L(s_0)) \}$

set of atomic propositions: $AP' = Q$

labeling function: $L'(\langle s, q \rangle) = \{q\}$

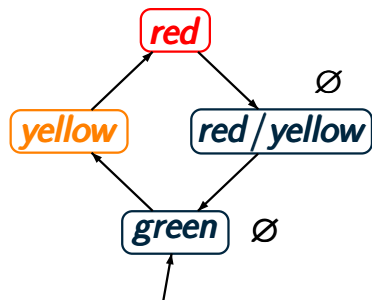

transition system \mathcal{T} over
 $AP = \{\text{red}, \text{yellow}\}$

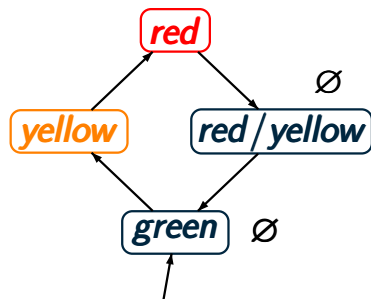

transition system \mathcal{T} over
 $AP = \{\text{red}, \text{yellow}\}$

\mathcal{T} satisfies the safety property E
“every red phase is preceded by a yellow phase”

Example: product-TS

IS2.5-26

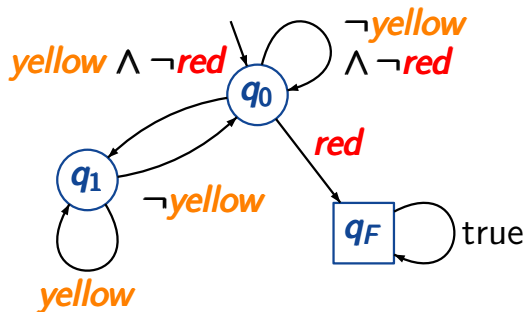
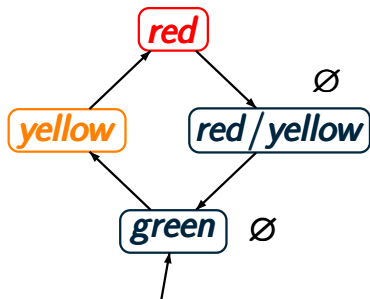

transition system \mathcal{T} over
 $AP = \{\text{red}, \text{yellow}\}$

DFA \mathcal{A} for the
bad prefixes for E

\mathcal{T} satisfies the safety property E
"every red phase is preceded by a yellow phase"

Example: product-TS

IS2.5-26

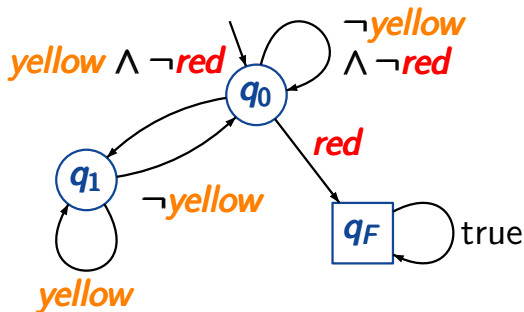
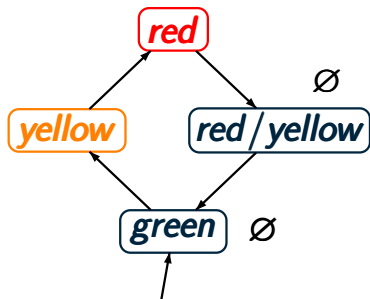

green q_0

red/yellow q_0

yellow q_1

red q_0

...

product-TS

$$\mathcal{T} \otimes \mathcal{A}$$

(4 * 3 = 12 states)

Example: product-TS

IS2.5-26

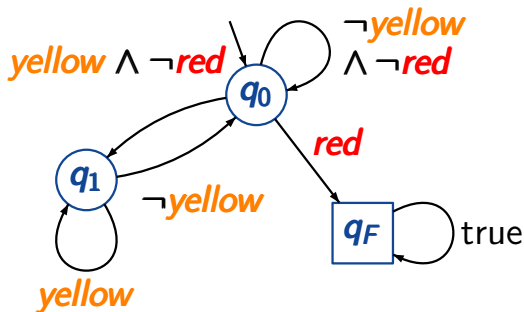
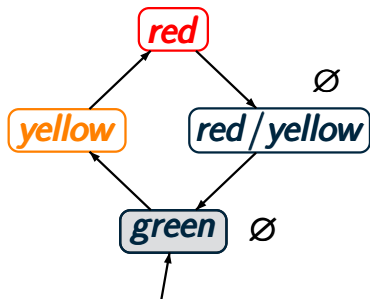

green q_0

red/yellow q_0

yellow q_1

red q_0

...

initial state
 $\langle \text{green}, \delta(q_0, \emptyset) \rangle$

$$L(\text{green}) \stackrel{\uparrow}{=} \emptyset$$

Example: product-TS

IS2.5-26

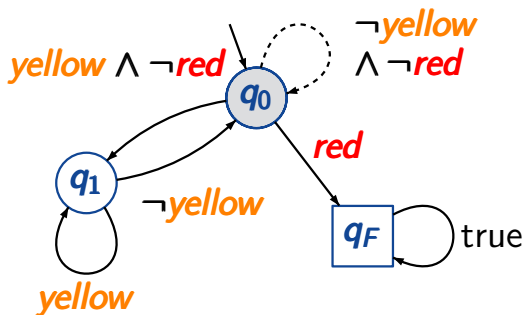
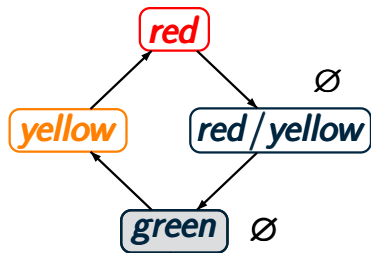

green q_0

red/yellow q_0

yellow q_1

red q_0

...

initial state
 $\langle \text{green}, \underbrace{\delta(q_0, \emptyset)}_{= q_0} \rangle$

Example: product-TS

IS2.5-26

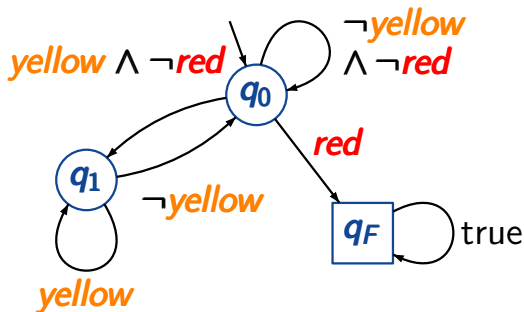
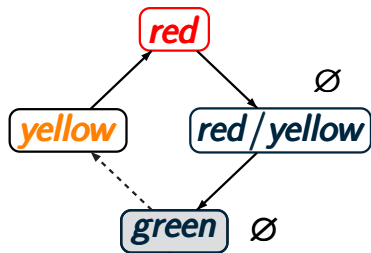

green q_0

red/yellow q_0

yellow q_1

red q_0

...

lifting the transition
green \longrightarrow **yellow**

Example: product-TS

IS2.5-26

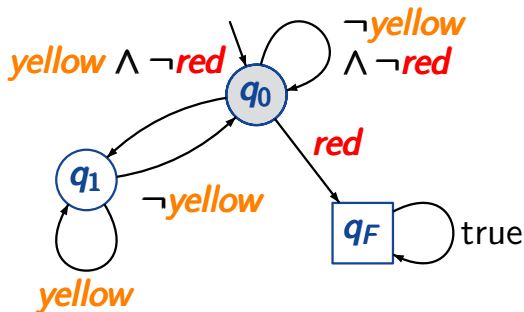
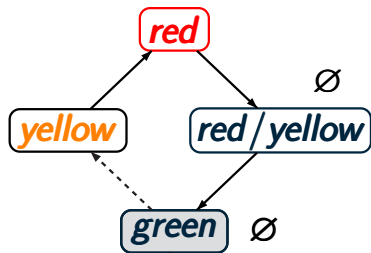

green q_0

red/yellow q_0

yellow q_1

red q_0

...

lifting the transition
 $green \rightarrow yellow$
 $\langle green, q_0 \rangle$
 \downarrow
 $\langle yellow, ? \rangle$

Example: product-TS

IS2.5-26

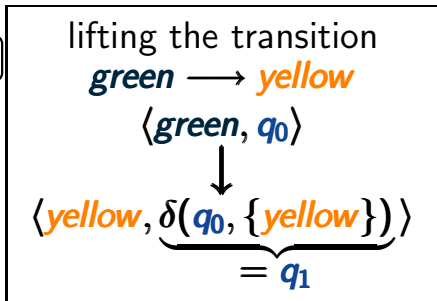
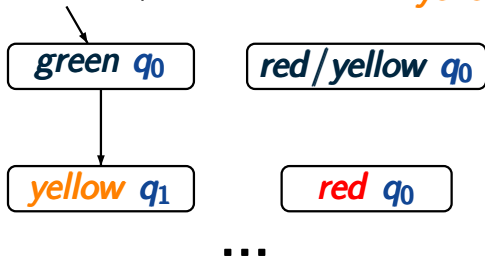
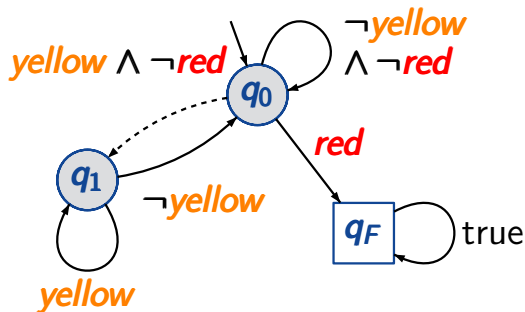
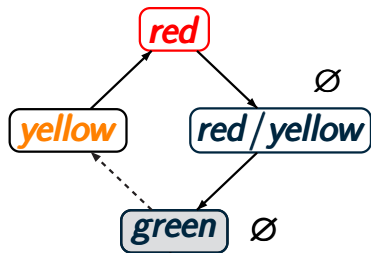

Example: product-TS

IS2.5-26

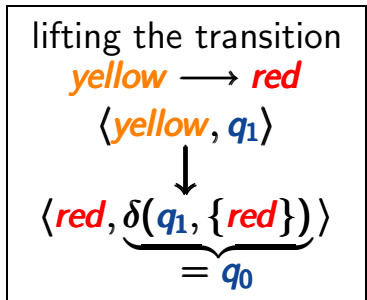
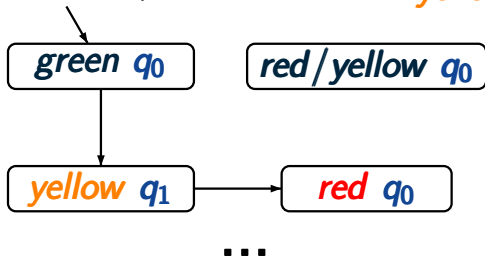
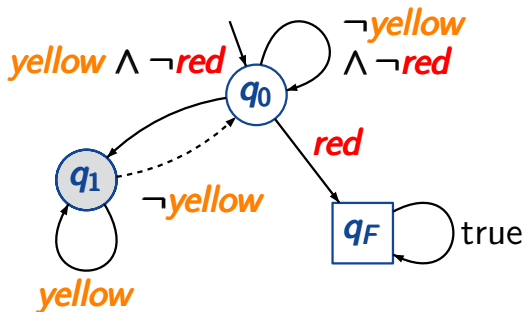
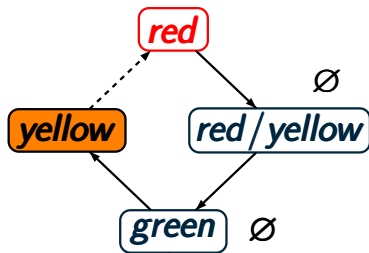

Example: product-TS

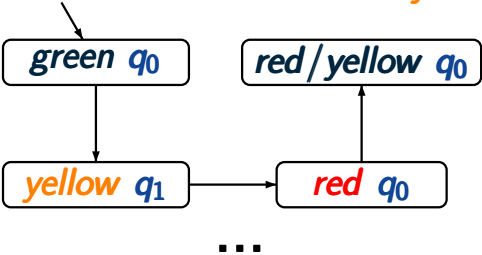
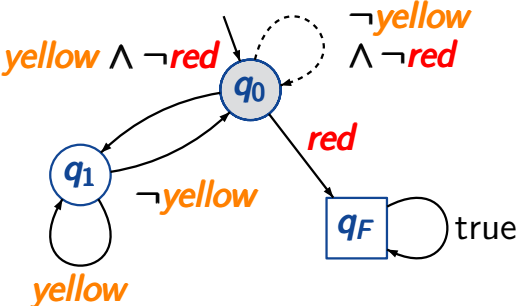
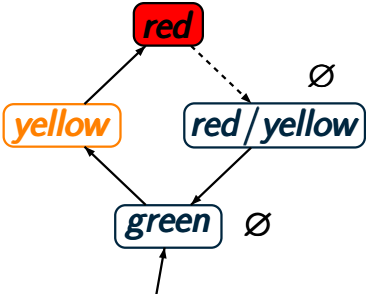

lifting the transition
 $red \rightarrow red/yellow$
 $\langle red, q_0 \rangle$
 \downarrow
 $\langle red/yellow, \underbrace{\delta(q_0, \emptyset)}_{= q_0} \rangle$

Example: product-TS

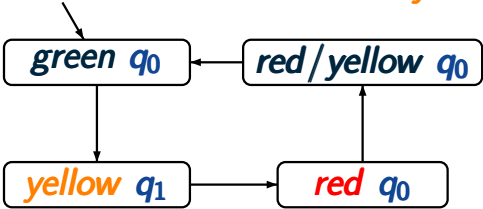
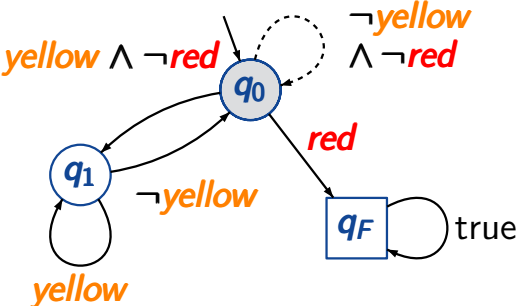
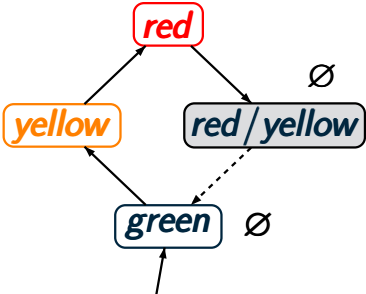

lifting the transition
 $red/yellow \rightarrow green$
 $\langle red/yellow, q_0 \rangle$
 \downarrow
 $\langle green, \underbrace{\delta(q_0, \emptyset)}_{= q_0} \rangle$

Example: product-TS

IS2.5-26

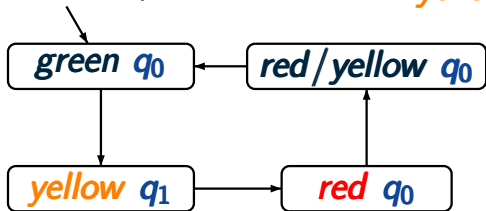
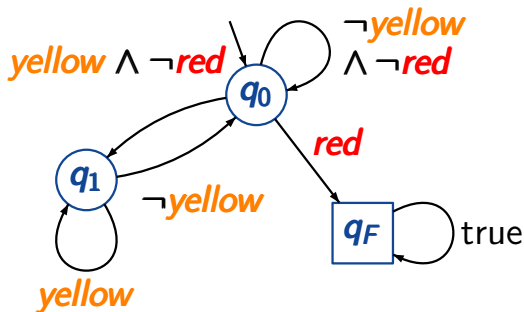
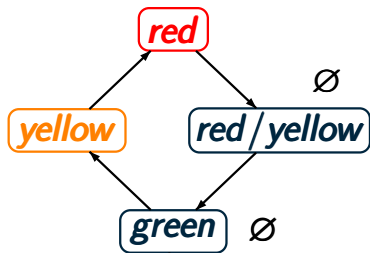

product-TS

$$\mathcal{T} \otimes \mathcal{A}$$

4 * 3 = 12 states, but
just 4 reachable states

Example: product-TS

IS2.5-26

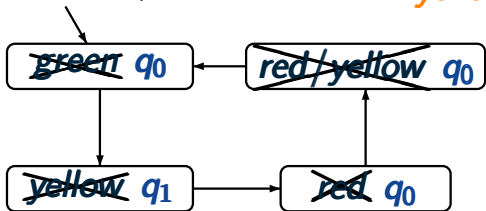
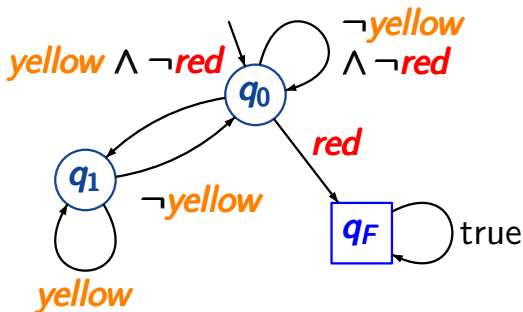
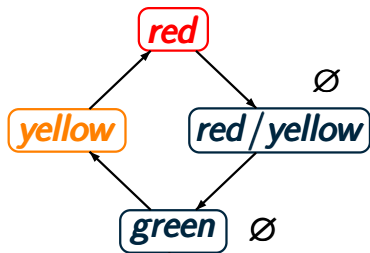

set of propositions
 $AP' = \{q_0, q_1, q_F\}$

Example: product-TS

IS2.5-26

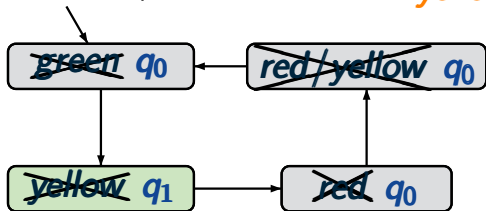
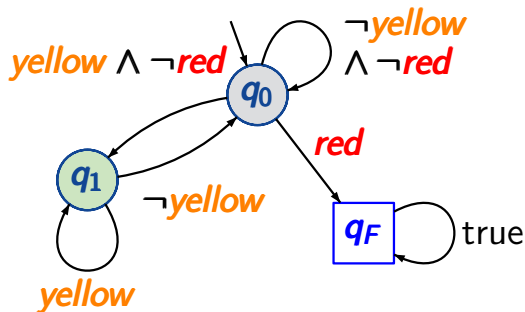
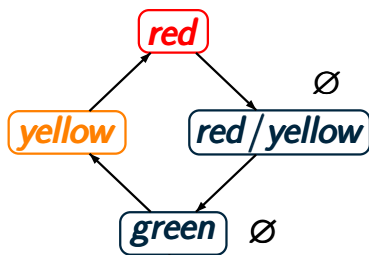

set of propositions
 $AP' = \{q_0, q_1, q_F\}$

invariant condition $\neg q_F$ holds
 for all reachable states

definition of the product of

- a transition system $\mathcal{T} = (S, Act, \rightarrow, S_0, AP, L)$

- an NFA $\mathcal{A} = (Q, 2^{AP}, \delta, Q_0, F)$

then the product $\mathcal{T} \otimes \mathcal{A} = (S \times Q, Act, \rightarrow', \dots)$ is a TS

definition of the product of

- a transition system $\mathcal{T} = (\mathcal{S}, \text{Act}, \rightarrow, \mathcal{S}_0, \text{AP}, L)$

↑
without terminal states

- an NFA $\mathcal{A} = (\mathcal{Q}, 2^{\text{AP}}, \delta, \mathcal{Q}_0, F)$

then the product $\mathcal{T} \otimes \mathcal{A} = (\mathcal{S} \times \mathcal{Q}, \text{Act}, \rightarrow', \dots)$ is a TS

definition of the product of

- a transition system $\mathcal{T} = (\mathcal{S}, \mathit{Act}, \rightarrow, \mathcal{S}_0, \mathit{AP}, \mathcal{L})$

without terminal states

- an NFA $\mathcal{A} = (\mathcal{Q}, 2^{\mathit{AP}}, \delta, \mathcal{Q}_0, \mathcal{F})$

then the product $\mathcal{T} \otimes \mathcal{A} = (\mathcal{S} \times \mathcal{Q}, \mathit{Act}, \rightarrow', \dots)$ is a TS

without terminal states

definition of the product of

- a transition system $\mathcal{T} = (\mathcal{S}, \text{Act}, \rightarrow, \mathcal{S}_0, \text{AP}, L)$

without terminal states

- an NFA $\mathcal{A} = (\mathcal{Q}, 2^{\text{AP}}, \delta, \mathcal{Q}_0, F)$

then the product $\mathcal{T} \otimes \mathcal{A} = (\mathcal{S} \times \mathcal{Q}, \text{Act}, \rightarrow', \dots)$ is a TS

without terminal states

assumptions on the NFA \mathcal{A} :

definition of the product of

- a transition system $\mathcal{T} = (\mathcal{S}, \text{Act}, \rightarrow, \mathcal{S}_0, \text{AP}, L)$

without terminal states

- an NFA $\mathcal{A} = (\mathcal{Q}, 2^{\text{AP}}, \delta, \mathcal{Q}_0, F)$

then the product $\mathcal{T} \otimes \mathcal{A} = (\mathcal{S} \times \mathcal{Q}, \text{Act}, \rightarrow', \dots)$ is a TS

without terminal states

assumptions on the NFA \mathcal{A} :

- \mathcal{A} is non-blocking, i.e.,

$$\mathcal{Q}_0 \neq \emptyset \wedge \forall q \in \mathcal{Q} \forall A \in 2^{\text{AP}}. \delta(q, A) \neq \emptyset$$

definition of the product of

- a transition system $\mathcal{T} = (\mathcal{S}, \text{Act}, \rightarrow, \mathcal{S}_0, \text{AP}, L)$

without terminal states

- an NFA $\mathcal{A} = (\mathcal{Q}, 2^{\text{AP}}, \delta, \mathcal{Q}_0, F)$

then the product $\mathcal{T} \otimes \mathcal{A} = (\mathcal{S} \times \mathcal{Q}, \text{Act}, \rightarrow', \dots)$ is a TS

without terminal states

assumptions on the NFA \mathcal{A} :

- \mathcal{A} is non-blocking, i.e.,

$$\mathcal{Q}_0 \neq \emptyset \wedge \forall q \in \mathcal{Q} \forall A \in 2^{\text{AP}}. \delta(q, A) \neq \emptyset$$

- no initial state of \mathcal{A} is final, i.e., $\mathcal{Q}_0 \cap F = \emptyset$

NFA \mathcal{A}

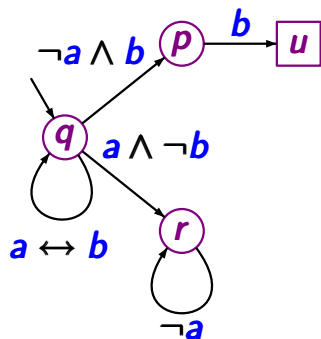

alphabet $\Sigma = 2^{AP}$ where $AP = \{a, b\}$

NFA \mathcal{A}

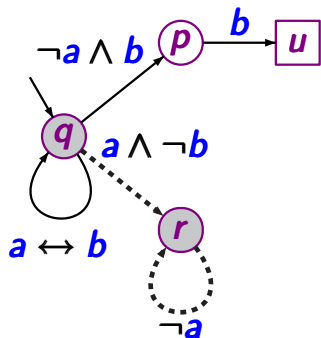

blocks for input
 $\{a\} \not\subseteq \{a\}$

alphabet $\Sigma = 2^{AP}$ where $AP = \{a, b\}$

Non-blocking NFA

IS2.5-23

NFA \mathcal{A}



equivalent NFA \mathcal{A}'

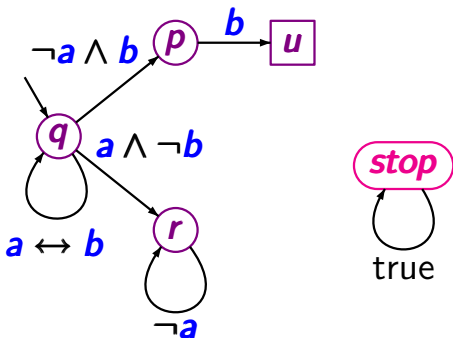
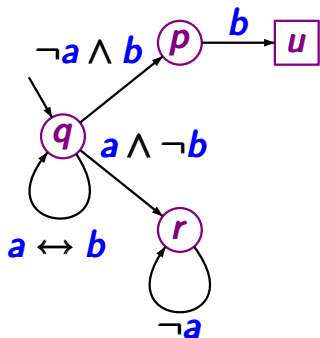

blocks for input
 $\{a\} \emptyset \{a\}$

add a trap state *stop*

Non-blocking NFA

IS2.5-23

NFA \mathcal{A}

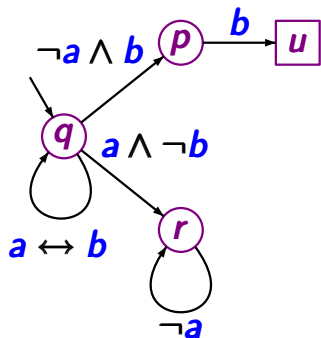

blocks for input
 $\{a\} \emptyset \{a\}$

\rightsquigarrow

equivalent NFA \mathcal{A}'

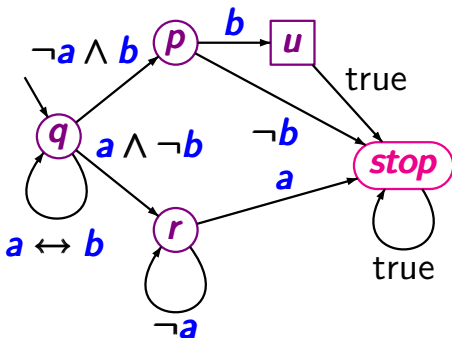

add a trap state *stop*

Non-blocking NFA

IS2.5-23

NFA \mathcal{A}

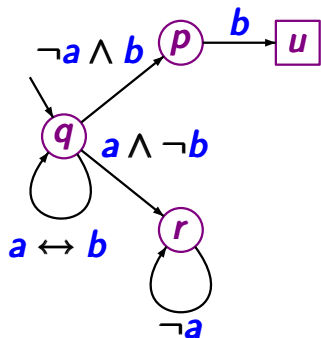

blocks for input
 $\{a\} \not\subseteq \{a\}$

\rightsquigarrow

equivalent NFA \mathcal{A}'

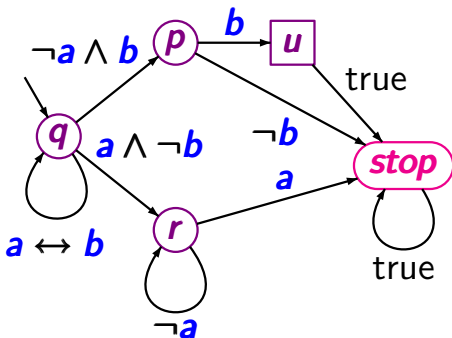

non-blocking

NFA where no initial state is final

IS2.5-24

NFA \mathcal{A} with $Q_0 \cap F \neq \emptyset$

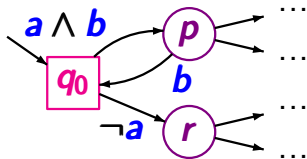

NFA where no initial state is final

IS2.5-24

NFA \mathcal{A} with $Q_0 \cap F \neq \emptyset$ \rightsquigarrow NFA \mathcal{A}' with $Q_0 \cap F = \emptyset$

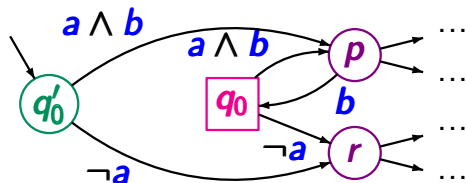
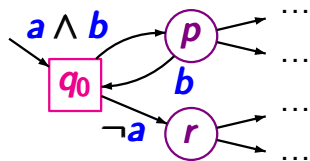

NFA where no initial state is final

IS2.5-24

NFA \mathcal{A} with $Q_0 \cap F \neq \emptyset$ \rightsquigarrow NFA \mathcal{A}' with $Q_0 \cap F = \emptyset$

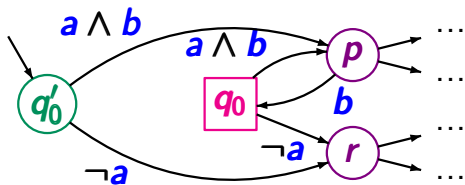
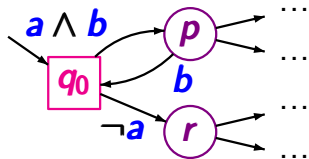

$$\mathcal{L}(\mathcal{A}') = \mathcal{L}(\mathcal{A}) \setminus \{\epsilon\}$$

NFA where no initial state is final

IS2.5-24

NFA \mathcal{A} with $Q_0 \cap F \neq \emptyset \rightsquigarrow$ NFA \mathcal{A}' with $Q_0 \cap F = \emptyset$

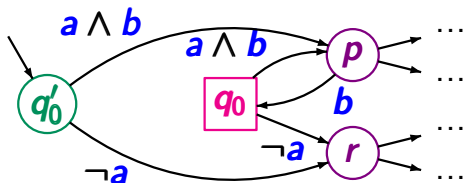
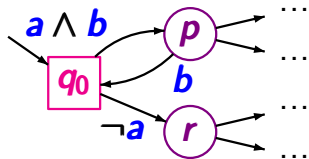

$$\mathcal{L}(\mathcal{A}') = \mathcal{L}(\mathcal{A}) \setminus \{\epsilon\}$$

note: if \mathcal{A} is an NFA for the bad prefixes of a safety property then

$$\epsilon \notin \mathcal{L}(\mathcal{A}) = \mathit{BadPref}$$

... via a reduction to invariant checking

Let $\mathcal{T} = (S, Act, \rightarrow, S_0, AP, L)$ be a transition system

$\mathcal{A} = (Q, 2^{AP}, \delta, Q_0, F)$ be an NFA
for the bad prefixes of a regular safety property E

Let $\mathcal{T} = (\mathcal{S}, \text{Act}, \rightarrow, \mathcal{S}_0, \text{AP}, L)$ be a transition system
(without terminal states)

$\mathcal{A} = (\mathcal{Q}, 2^{\text{AP}}, \delta, \mathcal{Q}_0, F)$ be an NFA
for the bad prefixes of a regular safety property E

Let $\mathcal{T} = (\mathcal{S}, \text{Act}, \rightarrow, \mathcal{S}_0, \text{AP}, L)$ be a transition system
(without terminal states)

$\mathcal{A} = (Q, 2^{\text{AP}}, \delta, Q_0, F)$ be an NFA
for the bad prefixes of a regular safety property E
(non-blocking and $Q_0 \cap F = \emptyset$)

Let $\mathcal{T} = (\mathcal{S}, \text{Act}, \rightarrow, \mathcal{S}_0, \text{AP}, \mathcal{L})$ be a transition system
(without terminal states)

$\mathcal{A} = (\mathcal{Q}, \Sigma^{\text{AP}}, \delta, \mathcal{Q}_0, \mathcal{F})$ be an NFA
for the bad prefixes of a regular safety property E
(non-blocking and $\mathcal{Q}_0 \cap \mathcal{F} = \emptyset$)

The following statements are equivalent:

- (1) $\mathcal{T} \models E$
- (2) $\text{Traces}_{\text{fin}}(\mathcal{T}) \cap \mathcal{L}(\mathcal{A}) = \emptyset$

Let $\mathcal{T} = (\mathcal{S}, \text{Act}, \rightarrow, \mathcal{S}_0, \text{AP}, \mathcal{L})$ be a transition system
(without terminal states)

$\mathcal{A} = (\mathcal{Q}, \Sigma^{\text{AP}}, \delta, \mathcal{Q}_0, \mathcal{F})$ be an NFA
for the bad prefixes of a regular safety property E
(non-blocking and $\mathcal{Q}_0 \cap \mathcal{F} = \emptyset$)

The following statements are equivalent:

- (1) $\mathcal{T} \models E$
- (2) $\text{Traces}_{\text{fin}}(\mathcal{T}) \cap \mathcal{L}(\mathcal{A}) = \emptyset$
- (3) $\mathcal{T} \otimes \mathcal{A} \models$ invariant “always $\neg \mathcal{F}$ ”

Let $\mathcal{T} = (\mathcal{S}, \text{Act}, \rightarrow, \mathcal{S}_0, \mathcal{AP}, L)$ be a transition system
(without terminal states)

$\mathcal{A} = (\mathcal{Q}, \Sigma^{\mathcal{AP}}, \delta, \mathcal{Q}_0, F)$ be an NFA
for the bad prefixes of a regular safety property E
(non-blocking and $\mathcal{Q}_0 \cap F = \emptyset$)

The following statements are equivalent:

- (1) $\mathcal{T} \models E$
- (2) $\text{Traces}_{fin}(\mathcal{T}) \cap \mathcal{L}(\mathcal{A}) = \emptyset$
- (3) $\mathcal{T} \otimes \mathcal{A} \models$ invariant “always $\neg F$ ”

where “ $\neg F$ ” denotes $\bigwedge_{q \in F} \neg q$

$\mathcal{T} = (S, Act, \rightarrow, S_0, AP, L)$ transition system

$\mathcal{A} = (Q, 2^{AP}, \delta, Q_0, F)$ NFA

product-TS $\mathcal{T} \otimes \mathcal{A} \stackrel{\text{def}}{=} (S \times Q, Act, \longrightarrow', S'_0, AP', L')$

$$\frac{s \xrightarrow{\alpha} s' \quad \wedge \quad q' \in \delta(q, L(s'))}{\langle s, q \rangle \xrightarrow{\alpha}' \langle s', q' \rangle}$$

initial states: $S'_0 = \{ \langle s_0, q \rangle : s_0 \in S_0, q \in \delta(Q_0, L(s_0)) \}$

set of atomic propositions: $AP' = Q$

labeling function: $L'(\langle s, q \rangle) = \{q\}$

Example: sequential circuit

IS2.5-27

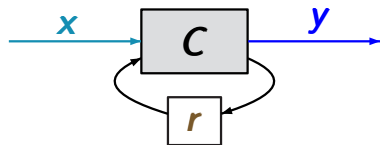

$$\lambda_y = \delta_r = x \oplus r$$

Example: sequential circuit

IS2.5-27

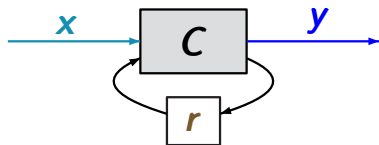

$$\lambda_y = \delta_r = x \oplus r$$

initially $r = 0$

transition system \mathcal{T}

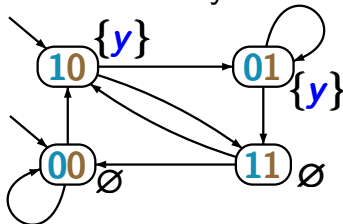

over $AP = \{y\}$

Example: sequential circuit

IS2.5-27

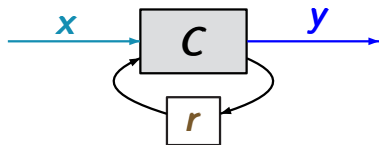

$$\lambda_y = \delta_r = x \oplus r$$

initially $r = 0$

transition system \mathcal{T}

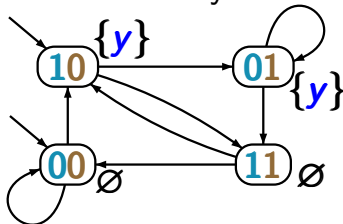

over $AP = \{y\}$

safety property E

The circuit will never output two ones after each other

Example: sequential circuit

IS2.5-27

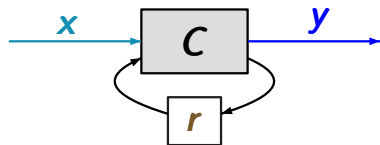

$$\lambda_y = \delta_r = x \oplus r$$

initially $r = 0$

transition system \mathcal{T}

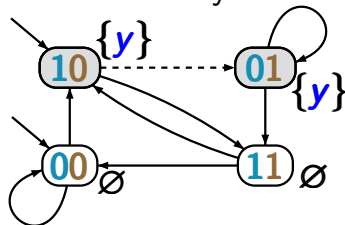

$\mathcal{T} \not\models E$

safety property E

The circuit will never output two ones after each other

Example: sequential circuit

is2.5-27

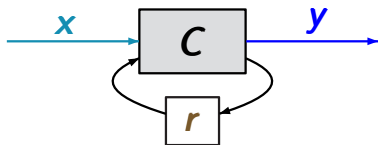

$$\lambda_y = \delta_r = x \oplus r$$

initially $r = 0$

transition system \mathcal{T}

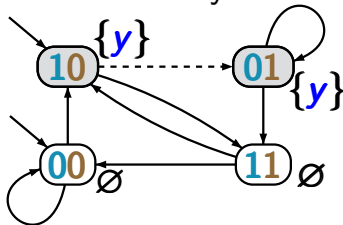

$\mathcal{T} \not\models E$

error indication, e.g.,
 $\langle 10 \rangle \langle 01 \rangle$

safety property E

*The circuit will never
output two ones
after each other*

Example: sequential circuit

IS2.5-27

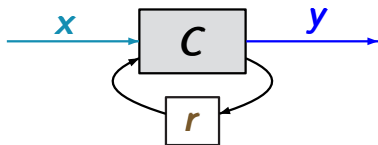

$$\lambda_y = \delta_r = x \oplus r$$

initially $r = 0$

transition system \mathcal{T}

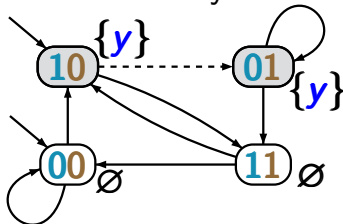

$\mathcal{T} \not\models E$

error indication, e.g.,
 $\langle 10 \rangle \langle 01 \rangle$

bad prefix: $\{y\} \{y\}$

safety property E

*The circuit will never
output two ones
after each other*

Example: sequential circuit

IS2.5-27

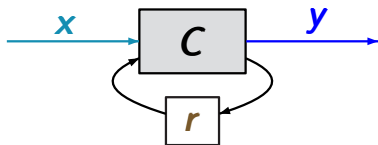

$$\lambda_y = \delta_r = x \oplus r$$

initially $r = 0$

transition system \mathcal{T}

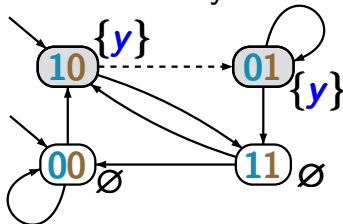

$\mathcal{T} \not\equiv E$

error indication, e.g.,
 $\langle 10 \rangle \langle 01 \rangle$

bad prefix: $\{y\} \{y\}$

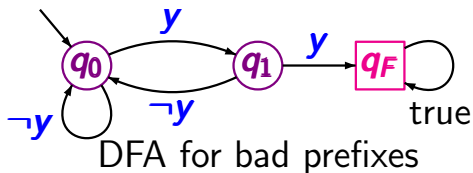

safety property E

The circuit will never output two ones after each other

Example: product-TS

IS2.5-28

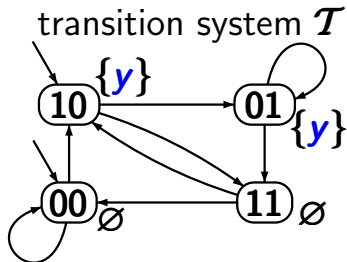

safety property E
... never two ones in a row ...

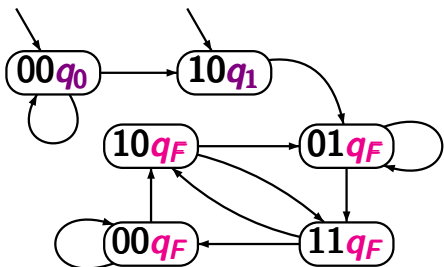
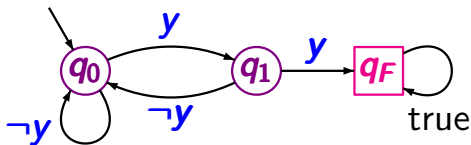

product-TS $\mathcal{T} \otimes \mathcal{A}$

Example: product-TS

IS2.5-28

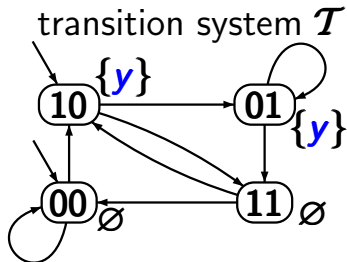

safety property E
... never two ones in a row ...

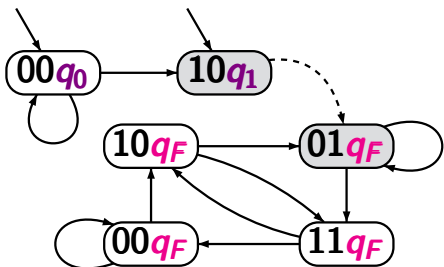
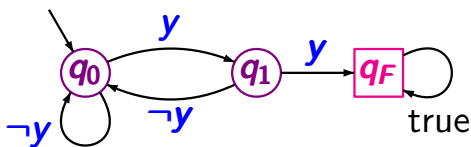

$\mathcal{T} \otimes \mathcal{A} \not\models$ "never q_F "

Example: product-TS

IS2.5-28

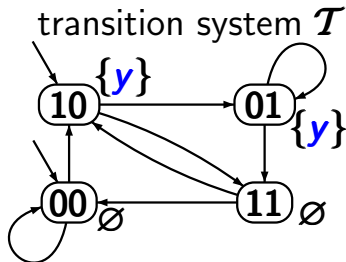

safety property E

... never two ones in a row ...

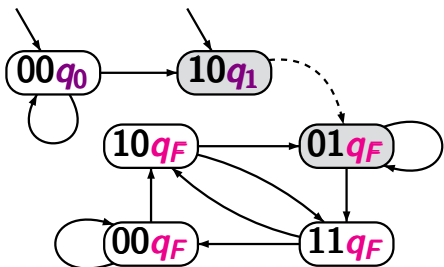
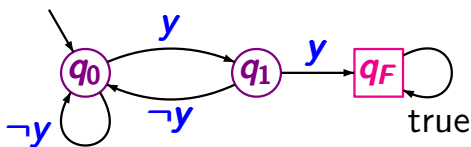

error indication for $\mathcal{T} \otimes \mathcal{A} \not\models$ "never q_F "

$10q_1$ $01q_F$

Example: product-TS

IS2.5-28

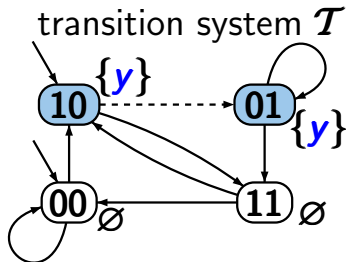

safety property E
... never two ones in a row ...

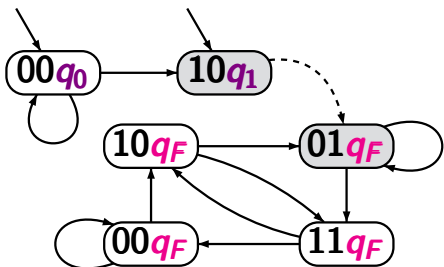
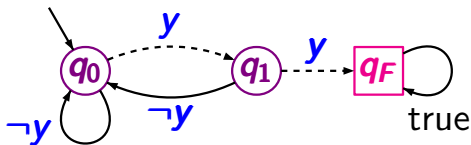

error indication for $\mathcal{T} \not\models E$

error indication for $\mathcal{T} \otimes \mathcal{A} \not\models$ "never q_F "

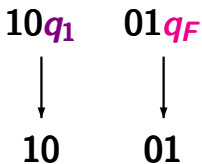

input: finite TS \mathcal{T} ,
NFA \mathcal{A} for the bad prefixes of E

output: “yes” if $\mathcal{T} \models E$
otherwise “no”

input: finite TS \mathcal{T} ,
NFA \mathcal{A} for the bad prefixes of E

output: “yes” if $\mathcal{T} \models E$
otherwise “no”

construct product transition system $\mathcal{T} \otimes \mathcal{A}$

check whether $\mathcal{T} \otimes \mathcal{A} \models$ “always $\neg F$ ”

where F = set of final states in \mathcal{A}

input: finite TS \mathcal{T} ,
NFA \mathcal{A} for the bad prefixes of E

output: “yes” if $\mathcal{T} \models E$
otherwise “no”

construct product transition system $\mathcal{T} \otimes \mathcal{A}$

check whether $\mathcal{T} \otimes \mathcal{A} \models$ “always $\neg F$ ”

if so, then return “yes”

if not, then return “no”

where F = set of final states in \mathcal{A}

input: finite TS \mathcal{T} ,
NFA \mathcal{A} for the bad prefixes of E

output: “yes” if $\mathcal{T} \models E$
otherwise “no” + error indication

construct product transition system $\mathcal{T} \otimes \mathcal{A}$

check whether $\mathcal{T} \otimes \mathcal{A} \models$ “always $\neg F$ ”

if so, then return “yes”

if not, then return “no” ← and an error indication

where F = set of final states in \mathcal{A}

construct product transition system $\mathcal{T} \otimes \mathcal{A}$

IF $\mathcal{T} \otimes \mathcal{A} \models \text{“always } \neg F\text{”}$

THEN return “yes”

ELSE

FI

construct product transition system $\mathcal{T} \otimes \mathcal{A}$

IF $\mathcal{T} \otimes \mathcal{A} \models$ “always $\neg F$ ”

THEN return “yes”

ELSE compute a counterexample for $\mathcal{T} \otimes \mathcal{A}$ and
the invariant “always $\neg F$ ”,

FI

construct product transition system $\mathcal{T} \otimes \mathcal{A}$

IF $\mathcal{T} \otimes \mathcal{A} \models$ “always $\neg F$ ”

THEN return “yes”

ELSE compute a counterexample for $\mathcal{T} \otimes \mathcal{A}$ and
the invariant “always $\neg F$ ”,

i.e., an initial path fragment in the product

$\langle s_0, p_0 \rangle \langle s_1, p_1 \rangle \dots \langle s_n, p_n \rangle$ where $p_n \in F$

FI

construct product transition system $\mathcal{T} \otimes \mathcal{A}$

IF $\mathcal{T} \otimes \mathcal{A} \models$ “always $\neg F$ ”

THEN return “yes”

ELSE compute a counterexample for $\mathcal{T} \otimes \mathcal{A}$ and
the invariant “always $\neg F$ ”,

i.e., an initial path fragment in the product

$\langle s_0, p_0 \rangle \langle s_1, p_1 \rangle \dots \langle s_n, p_n \rangle$ where $p_n \in F$

return “no” and $s_0 s_1 \dots s_n$

FI

construct product transition system $\mathcal{T} \otimes \mathcal{A}$

IF $\mathcal{T} \otimes \mathcal{A} \models$ “always $\neg F$ ”

THEN return “yes”

ELSE compute a counterexample for $\mathcal{T} \otimes \mathcal{A}$ and
the invariant “always $\neg F$ ”,

i.e., an initial path fragment in the product

$\langle s_0, p_0 \rangle \langle s_1, p_1 \rangle \dots \langle s_n, p_n \rangle$ where $p_n \in F$

return “no” and $s_0 s_1 \dots s_n$

FI

time complexity: $\mathcal{O}(\text{size}(\mathcal{T}) \cdot \text{size}(\mathcal{A}))$

If \mathcal{T} is a finite transition system then
 $Traces_{fin}(\mathcal{T})$ is regular.

If \mathcal{T} is a finite transition system then
 $Traces_{fin}(\mathcal{T})$ is regular.

correct.

If \mathcal{T} is a finite transition system then
 $Traces_{fin}(\mathcal{T})$ is regular.

correct. \mathcal{T} can be transformed into an **NFA**.

If \mathcal{T} is a finite transition system then
 $Traces_{fin}(\mathcal{T})$ is regular.

correct. \mathcal{T} can be transformed into an **NFA**.

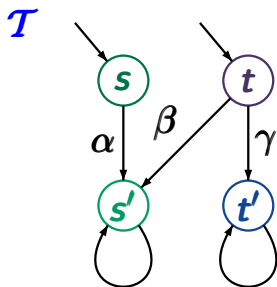

If \mathcal{T} is a finite transition system then
 $Traces_{fin}(\mathcal{T})$ is regular.

correct. \mathcal{T} can be transformed into an **NFA**.

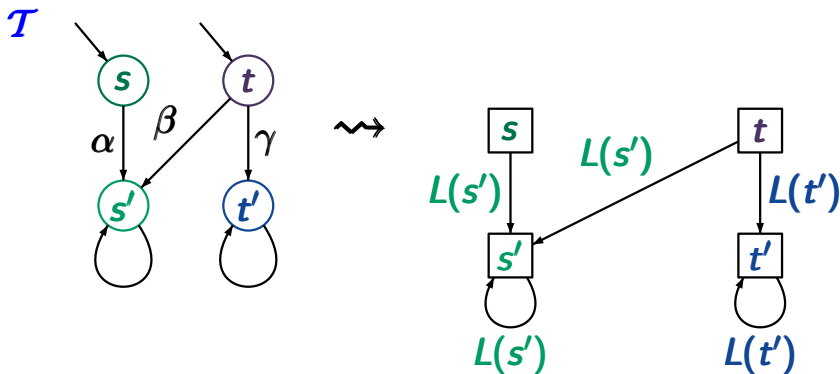

Correct or wrong?

IS2.5-35

If \mathcal{T} is a finite transition system then
 $Traces_{fin}(\mathcal{T})$ is regular.

correct. \mathcal{T} can be transformed into an NFA.

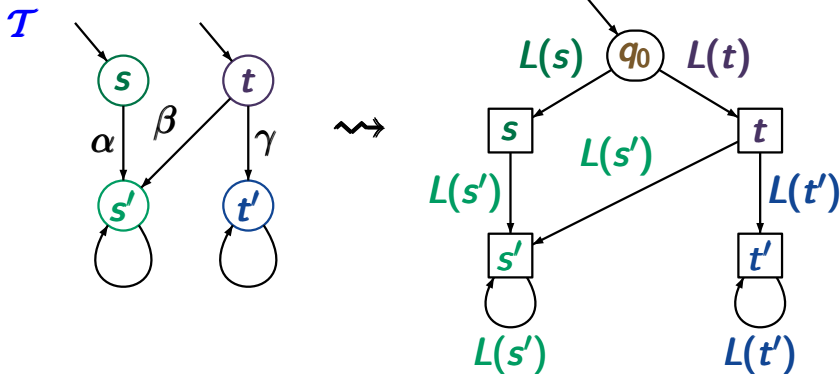

Correct or wrong?

IS2.5-35

If \mathcal{T} is a finite transition system then
 $Traces_{fin}(\mathcal{T})$ is regular.

correct. \mathcal{T} can be transformed into an NFA.

